



OWNERS MANUAL

12 NOVEMBER 2024

- ✓ High quality, efficient and energy saving
- ✓ Industry leading technology and innovation

- EG-450FRECW-4.8HP-4.8E
- EG-450FRECW-3.6HP-4.8E
- EG-215FREC-W



RAPID BOOST



Wi-Fi



ECOGENICA
INNOVATION MEETS TECHNOLOGY

The Ecogenica® W Series – Contents

The water heater must be maintained in accordance with the Owner's Guide and Installation.

- Care must be taken to ensure the system is installed in accordance to AS/NZS 2712 and must comply with A60335.2.40:2019 - Household and similar electrical appliances.
- The installation conforms to the Plumbing Code of Australia (PCA). regulations of the local authority. in line with national building regulations and local occupational health and safety regulations.
- **Do not operate this Heat Pump without a full tank of water.**
- **Do not operate this heat pump without both top and bottom temperature sensors correctly inserted and installed by a qualified installer.**
- *Thank you for choosing the Ecogenica W-Series Heat Pump Water Heater. Designed and developed in Australia for Australian conditions, and a Smart sustainable future..*

The W-Series uses the natural refrigerant R 290, which absorbs heat energy more efficiently for a cleaner environment. R290 (propane) is NOT a proscribed refrigerant.

Section	Content	Page
1	Warning & Safety Information	3
2	Installation cautions	4
3	Pre-installation	5
4	Installation	7
5	Operation	8
6	System maintenance	9
7	Specifications & drawings	10
8	Electrical & Controls	14
9	Warranty	18

1. Warning & Safety Information

WARNING – FOR CONTINUED SAFETY OF THIS APPLIANCE IT MUST BE INSTALLED, OPERATED AND MAINTAINED IN ACCORDANCE WITH THE MANUFACTURER'S INSTRUCTIONS.

WARNING-THIS APPLIANCE MAY DELIVER WATER AT HIGH TEMPERATURE. REFER TO THE PLUMBING CODE OF AUSTRALIA(PCA), LOCAL REQUIREMENTS AND INSTALLATION INSTRUCTIONS TO DETERMINE IF ADDITIONAL DELIVERY TEMPERATURE CONTROL IS REQUIRED.

WARNING

- RCBO circuit breaker must be installed.
- Do not remove, cover, or damage any permanent instructions or labels from the exterior or interior of the unit panel.
- Only qualified personnel should install in accordance with local and national regulations and this guide. Improper installation may cause water leakage, electric shock, or fire alarm.
- All electrical connections must comply with the requirements of the local power company, and this guide. Do not use rated fuse, otherwise it may malfunction and cause electrical fire.
- Do not insert fingers, rods or other objects into the air inlet or outlet. The fan is rotating at high speed, which may cause injury. Do not use flammable sprays, such as hairspray or paint near the machine to avoid fire.
- Your heat pump contains electrical components. Do not dispose of electrical appliances as unsorted municipal waste, a separate collection facility should be used. Contact your local government to find out information about the collection system. If electrical appliances are disposed of in landfills or dump sites, hazardous substances can seep into groundwater and cause health problems.
- The unit must be fixed firmly, otherwise noise and vibration may be generated. Ensure there are no obstacles around the device. In places with strong wind (such as seaside areas), the unit should be installed in a windproof place.
- The pressure release valve (PTR) should be opened every 6 months to ensure that the valve does not have any restrictions. The drainpipe should be well insulated to prevent the water in the pipe from freezing in cold weather.
- The ground electrode must be well grounded. Make sure all electrical sockets and plugs are dry and tightly connected. This unit requires reliable earthing.



Poor electrical circuits and wiring can be dangerous and may result in death or injury.

- Before cleaning, be sure to stop operation and isolate the unit (i.e. turn off the isolating switch or circuit breaker), otherwise, electric shock or injury may occur.
- Water temperature over 50 degrees Celsius will cause severe burns and even death.
- Children, the disabled and the elderly are at highest risk of burns. Feel the water temperature with your hands before showering or taking a bath to avoid burns.
- To avoid an electric shock, do not operate the machine with wet hands.
- A one-way check valve and a suitable isolation valve must be installed on the water inlet side.
- It is normal for the (PTR) to release some water during operation. However, if there is a large amount of water, please contact our service team. Improper drainage can cause water damage to surrounding areas such as buildings, furniture, etc.
- Except for repair and maintenance purposes, do not turn off the power, especially in cold weather as it may freeze the machine. Continuously powered heating water is necessary.
- Do not puncture the water heater casing, smoke, or activate sparking of any description within 1.5 meters of this water heater.
- Compliance with national gas regulations should be observed. This water heater contains flammable propane refrigeration in a sealed closed refrigeration circuit.
- We recommend keeping children away from the Heat Pump.
- If the hot water system is not in use for several weeks, a quantity of hydrogen gas may accumulate in the water heater. To dissipate the gas safely, please turn on the hot water taps for several minutes to ensure that gas has been properly removed from the water heater. As the air escapes, sounds may occur which is normal.
- Under no circumstances should "home craft" type modifications be attempted. This appliance is not intended for use by persons (including children) with reduced physical sensory or intellectual abilities, or who lack the experience and knowledge to safely use this appliance without supervision or instruction. Children should be supervised by a responsible person to ensure their safety.

WARNING



2. Installation cautions

PLUMBING

- Care must be taken to ensure the system is installed in accordance with AS/NZS 2712 and to AS/NZS 60335.2.40:2019 - with household and similar electrical appliances.
- The Ecogenica FR & FREC Models use natural refrigerant alternative R290 (propane).
- Since heat pump water heaters can generate water temperatures more than +50 degrees Celsius, regulations require that a regulating valve be installed on the hot water outlet line of the water heater to prevent the water temperature from exceeding a pre-set safety upper limit.
- The installation must conform with the Plumbing Code of Australia (PCA), regulations of the local authority, in line with national building regulations and local occupational health and safety regulations. Only licensed professionals will issue a certificate of compliance, certifying that the work in question meets all relevant standards, and only licensed professionals will take out craft insurance. The water heater must be maintained in accordance with this manual and Installation Instructions.

CUSTOM INSTALLATION

- Please consult with Ecogenica about internal installations. If a safety tray is required to prevent building damage, construction, installation and draining of a safe tray must comply with AS/NZS 3500.4 and all local codes and regulatory authority requirements.
- Ensure that the heat pump unit is installed in a compliant and accessible location is crucial for maintaining its warranty and ensuring efficient service. Please refer to the installation guidelines in this manual for detailed information on compliant installation practices.

DISPOSAL

Please note, the tank and heat pump must have the natural gas released, before the units are sent to metal recycling, or to your local council appliance recycling centre.

Plumbing must be well insulated. Lagging must be applied to pipes and valves for at least the first 500 mm in all directions, including PTR drainpipes. Customer should consider investing in best practice plumbing to have external hot water pipework to the primary kitchen sink lagged. As every home is different pipework plumbing insulation in the home is quoted separately.

All installations of Ecogenica Heat Pump systems must comply with the AS3000 electrical standards. It is the responsibility of the licensed electrician to ensure that all wiring, power supply connections, and protective devices adhere to these regulations to guarantee safe and effective operation.

CIRCUIT BREAKER

- The hot water pump power supply must be protected by a separate RCBO on the main power switchboard and rated to suit the size of the components. Do not connect other appliances, especially high-power appliances, to the main power supply of the water heater, to ensure it operates without interference.
- These models MUST be installed on their own dedicated circuit to avoid overloading and ensure proper operation

CONDENSATION DRAIN

- The heat pump must be installed on a flat dry surface. If there is no special drainage pipe (sink), be sure to ensure that the condensed water flowing on the ground can be drained smoothly to avoid water pooling around the heat pump. As condensate will otherwise drip from the appliance onto the floor if the drainpipe is not added.

P&T VALUE DRAIN LINE

- A drain line from a relief valve must comply with the requirements of AS/NZS 3500.4. The outlet of a drain line must be easily seen, and arranged so discharge will not cause injury, damage, or nuisance. Drains from the water heater must be directed away from the building, fall continuously, discharge water away from the operator during the operation of the valve, and PTR drains must use copper piping.

GROUND CONNECTIONS

- Proper ground connection is essential. The presence of water in the piping and water heater does not provide sufficient conduction for a ground. Non-metallic piping, dielectric unions, flexible connectors plumbing etc., can cause the water heater to be electrically isolated.

3. Pre-Installation

REQUIREMENT: When choosing a suitable location, the following factors should be considered:

- Ensure that there is enough space for installation and future maintenance. Do not install the heat pump in an area that is not easily accessible for maintenance and repair work. This includes installations in confined spaces, locations requiring special equipment to access, or areas that pose a safety risk to our technicians.
- The inlet and outlet should be free of obstacles and strong winds.
- The bottom surface should be flat and capable of bearing the weight of the heat pump, while ensuring that no noise and/or vibration will be increased.
- Secure the device to help avoid unnecessary noise and/or vibration. The outdoor unit (Heat Pump) is installed with a 25mm high rubber shockproof, and it is firmly fixed with studs to avoid noise when the machine is running.
- The running noise and the exhausted airflow should not affect other people. Take care to consider the location of bedrooms and noise sensitive areas.
- Unsafe Installation location: Installation must comply with safety standards and regulations. Including, and not limited to, areas with inadequate ventilation, proximity to hazardous materials, or installations that violate manufacturer guidelines.
- Installations indoors are not recommended, and permission must be secured from Ecogenica.

- Ensure that the electrical insulation complies with the relevant local standards.
- Do not install in areas where acidic or alkaline gases are present. Make sure there is no flammable gas nearby.
- **TRANSPORT:** When shipping this item, the following rules must be followed:
When moving, do not make the fuselage deviate from the vertical angle by more than 25 Degrees. Keep vertical. To avoid scratches or damage, please use protective covering where applicable.
- Since the machine is heavy, it needs two or more people to carry it, to avoid injury and/or damage.
- Since the machine is heavy, it will need two or more people to carry it, to avoid injury and/or damage.
- Do not install in areas with pH & chlorides outside the range listed here (pH 6 to 10) & Chloride >200):

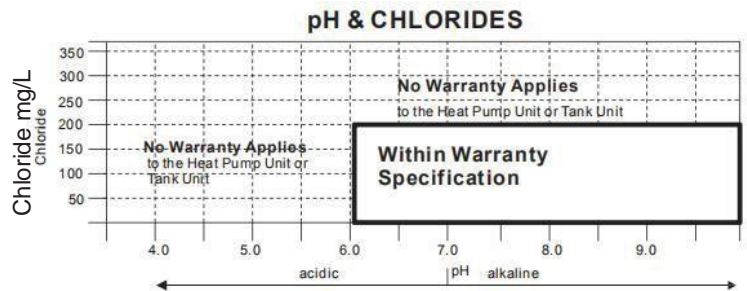
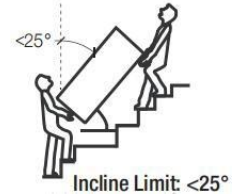

QUICK CONNECT INSTALLATION

Quick connects ③ ④ are already welded to the tank and filled with refrigerant.

Please choose a correct position before connecting the copper condenser pipes.

Make sure the connector (male) is connected to the connector (female). Please use a hexagon spanner to open-up the refrigerant valve.

Please check and make sure there is no refrigerant leak.

- 1 and 2 - Cover
- 3 - 9.52 ø copper tube (2m)
- 4 - 6.35 ø copper tube (2m)
- 5 - Connector (female) 1/4
- 6 - Connector (female) 3/8
- 7 - Connector (male) 1/4
- 8 - Connector (male) 3/8
- 9 - Hexagon spanner

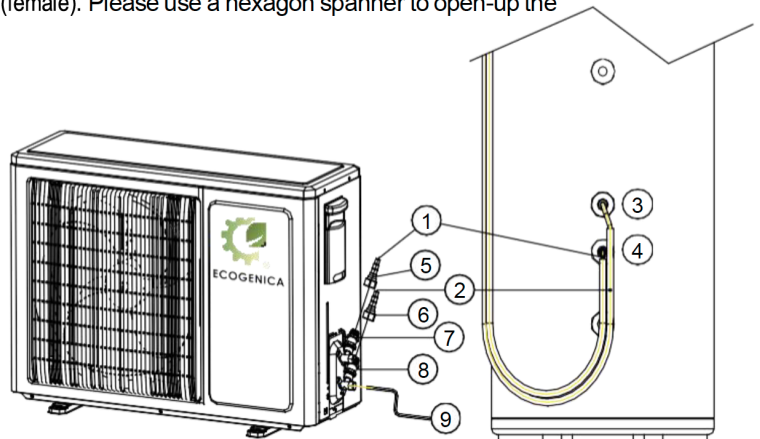

Plumbers – Best Practice is required please conduct the following check list before you finish and ensure that Valves easily accessible and all drainage doesn't damage buildings.

4. Installation

PIPING CONNECTIONS

- EG-450FRECW-4.8HP-4.8E and EG-450FRECW-3.6HP-4.8E have G1 1/4-inch (32mm ID) female connections, and a reducer to 3/4" (20mm), can be supplied.
- The outlet of the PTR valve is a 3/4" (20 mm) female fitting.
- All hot water pipes must be insulated for safety and insulation.
- Ensure the site is suitable for draining the tank at some future time.

- 1 Cold Water Supply Outlet
- 2 Connecting Pipe
- 3 Water Temperature Sensor (Middle)
- 4 Water Temperature Sensor (upper)
- 5 Hot Water Supply Outlet
- 6 PTR Relief Valve (Max working pressure):
 - EG-215FREC-W (850kPa)
 - EG-450FRECW-3.6HP-4.8E (850kPa)
 - EG-450FRECW-4.8HP-4.8E (850kPa)
- 7 Isolation Valve
- 8 Pressure Reduction Valve (500kPa)
- 9 One-way Valve (non-return)
- 10 Thermostatic Valve
- 11 Booster element

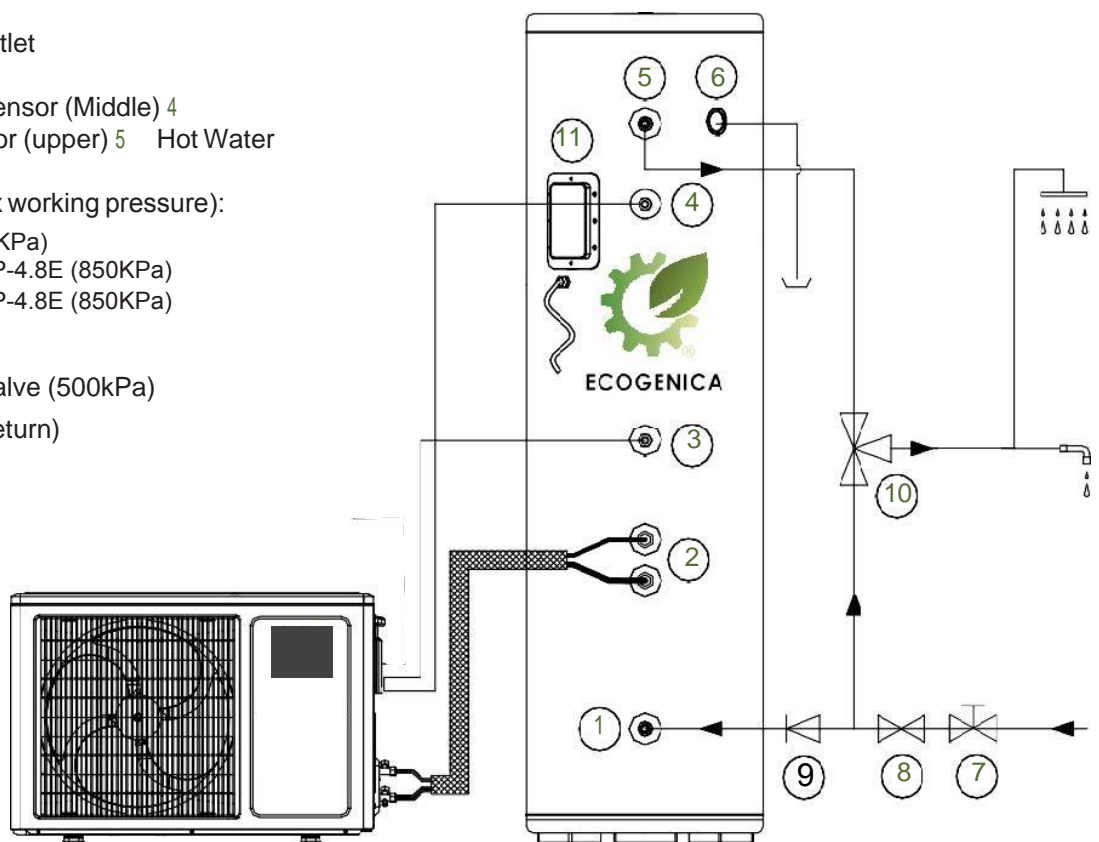

CAUTIONS

- A minimum water supply pressure of 200kPa is required to assure the effective operation of this water heater.
- Be careful when the heat pump is operating. If there is water flowing out, it is considered that the PTR Valve is in normal use otherwise, the PTR Valve needs to be replaced (be careful of burns).
- All piping must be insulated for at least the first 500 mm, and compliant to the Australian plumbing code and Standard AS/NZS 3500.4:2021,

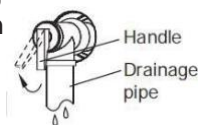

During the use of the machine, a small amount of water will leak out at the outlet of PTR Valve, which is normal, but drainage treatment must be done regardless and must comply with AS/ NZS3500.4.



WARNING

- Do not disassemble the PTR valve.
- Do not block the condensate drain line.

- This water heater is designed for direct connection to mains water supply.
- Ensure that the white insulation provided is covering all the hydraulic components (i.e. condenser pipes).
- If the water inlet pressure is less than 200 kPa, a booster pump should be installed at the water inlet.
- If the water inlet pressure exceeds 500 kPa, a pressure reducing valve is to be installed on the water inlet pipe.
- Draining of the existing tank can be accomplished by the connection of a hose to the cold-water inlet and running to a suitable drain. It will be necessary to disconnect the hot water outlet or PTR valve to relieve any partial vacuum created as the water flows out.

4. Installation

HEAT PUMP UNIT INSTALL POSITION

- The bottom surface for the Tank and Heat Pump (box) should be dry and flat, and capable of bearing three times the weight of the Tank and Heat Pump
- Install as per diagrams ensuring adequate air circulation and 100mm to 300mm space behind the unit outside and the wall. Do not obstruct in front of the air outlet, as this will affect the smooth air circulation. You should also avoid the windward direction.
- If there is no special drainage pipe (sink), be sure to ensure that the condensed water flowing on the ground can be drained smoothly. The Condensate Drain is located at the base of the heat pump, and it must be directed away from building footings.
- The outdoor unit is to be installed with rubber shock proofing, and it is to be firmly fixed to studs when mounting the heat pump on the wall.

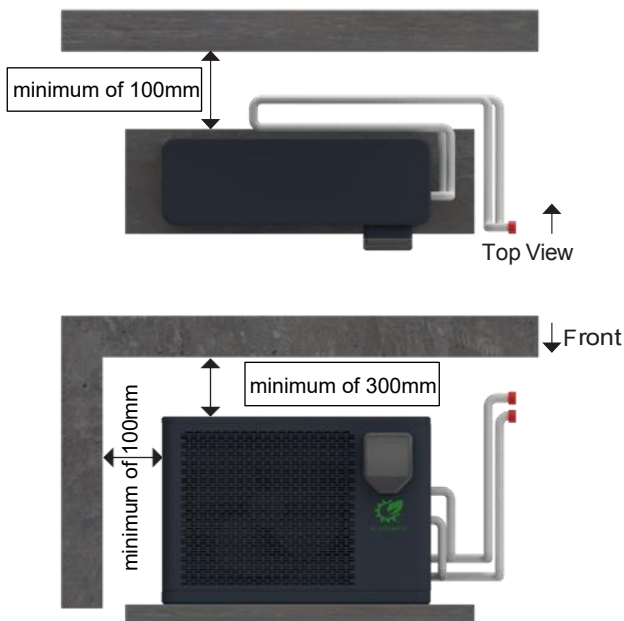

WATER TANK INSTALL POSITION

- The water storage tank must be placed upright on the ground, with a 10cm foot pad under it. The installation site must have a solid foundation and must be able to withstand a weight of more than 500kg.
- The hot water tank must not be mounted on the wall.
- It's important to ensure that no air locks exist in the hot water line. When filling the water tank open the isolation inlet valve, make sure that a tap is open, within in the home, to ensure that water comes out of the tap at full capacity tank.
- Ensure the faultless operation the unit must be installed vertically without noticeable tilt.

REFRIGERATION PRE-CHARGED COUPLING

- This unit contains precharged couplings (**do not evacuate the system; unless authorised**), and once installed they cannot be re-used.
- Installers connect the male and female couplings creating one-shot connection. During this process the copper diaphragm in the female coupling is pierced and folded back into the coupling, providing a high flow path and low pressure drop for the refrigeration charge in the condenser (located on the water tank) to combine with the heat pump charge.
- The final step simple requires the installer to use an Allen key, to activate the precharged natural gas system . Both the high-pressure and low-pressure valves on the outside condenser must be fully opened, which will require several turns and then the heat pump is ready for plumbing connections.

Power Requirements (all models)

- Check the markings on the rating plate of the water heater to be certain the available power supply corresponds to the water heater requirements. The Heat Pump Water Heater must be directly connected to a 230V-240VAC 50Hz mains power supply. The water heater Heat Pump must be installed on separate individual circuits with a RCBO breaker switch installed directly at the switchboard. The power supply circuit of the Heat Pump must have an effective ground wire, and the power ground wire must be reliably connected to the external ground wire.
- Please arrange the power supply layout neatly and reasonably and avoid splicing wires. The appliance must be powered for the first time after the tank was filled with water in accordance with the relevant regulations on electrical safety and electrical wiring.
- Wi-Fi: to connect Wi-Fi to the Ecogenica, or TUYA application, pair the heat pump to the Smart device controller (App). The application needs to be down -loaded to your device.
- Solar Power – In Summer you can choose to set the Heat Pump to run between 10am and 5pm using the timer. In colder months we suggest you run the heater in Auto Mode without the timer. If connected off grid, please make sure UPS power supply and the 230V-240VAC 50Hz true sine wave power supply is available.
- The hot water heat pump supply must be protected by a separate RCBO on the main switchboard, and rated to suit the size of the components. Do not connect other appliances ,especially high powered appliances, to main power supply of the water heater to ensure it operates without interference.

5. Operation

PREPARATION BEFORE OPERATION

Operation without water in the water tank may cause the water heater to enter a protection state, which may damage components in severe cases. In the event of such damage, the manufacturer will not be responsible for any damage caused by this issue. Before trial operation, please follow the steps. Note, Trial run must be done after all installations are complete.

POWER CONNECTION CAUTIONS

- Before turning on the power to the unit, double-check that the water tank is full of water.
- Do not change the set water temperature, this heater will self-adjust and heating the stored water to target temperature.
- Do not operate this Heat Pump without a full tank of water. Do not operate this heat pump without both top and bottom temperature sensors correctly inserted and installed by a qualified installer.
- No need to operate the display, the display is in the power-on state by default.
- The device has a three-minute delay start function, please be patient.
- After running for 30 minutes, observe the running status, if there is any problem, please check the display. If there is a fault code displayed on the screen contact Ecogenica.

RUNNING DYNAMICS

- There are different heating times at different ambient temperatures.
- Typically, lower ambient temperatures result in longer heat times and therefore performance.

PRODUCTION METHOD (SELF-PROTECTION)

- When the self-protection mode is activated, the system will stop and start self-checking. It will instigate operations to resolve the error and when resolved, the unit will restart. The error code will be displayed on the screen until the error is resolved. The device can enter self-protection mode under various conditions, including but not limited to:
 - Blocked air inlet or outlet the evaporator is covered with too much dust.
 - The unit receives incorrect power (over the 220-240v range).

REFRIGERATION ADDITION

- Please contact Ecogenica for instructions and approval. Only use R290 natural refrigerant.

INSTALLATION CHECK LIST:

	Piping and wiring are correct
	Drainage and emptying are smooth without leakage
	Plumbing installed correctly
	The power supply voltage is consistent with the rated voltage of the unit
	The air inlet and outlet of the unit are barrier-free

The Ecogenica Heat Pump Water Heater consists of 3 main components. 1. The Condenser tank - which heats the water; 2. The pair coil or condenser pipe, which transfers heat to the tank; 3. The Heat Pump which heats natural refrigerant. The Heat Pump contains an Evaporator, which absorbs heat from the air, and a Compressor Assemble, which turns the energy absorbed from the air into super heated natural refrigerant (via compression of the R290 natural refrigerant gas).

For more information on operation see section 7 Specification & Drawings and go to exploded view, or Setion 8 Electrical and Controls.

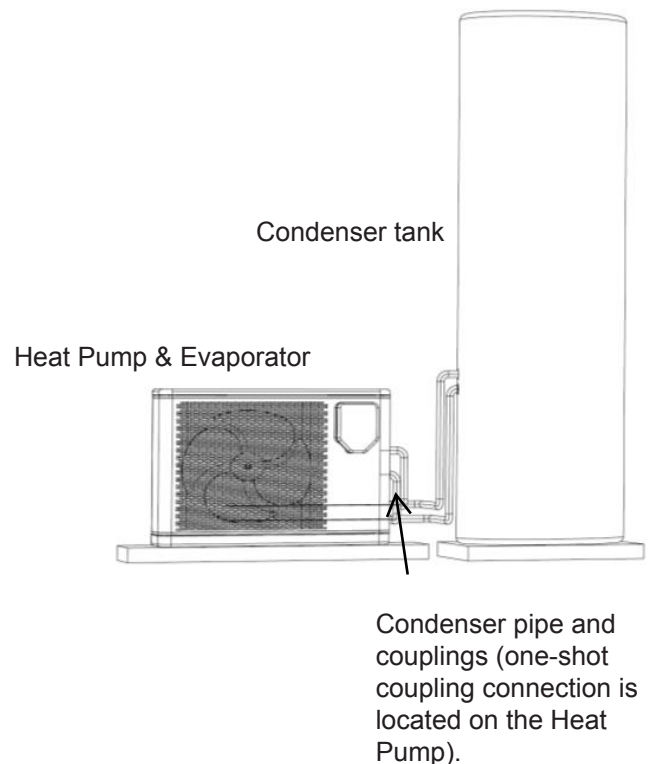

5. System Maintenance

- The efficiency of the Heat Pump depends on whether there is dust, mud or other on the surface of the evaporator. Sundries block the air inlet channel and lose the effect of heat exchange with the air, resulting in a loss of heating efficiency. Customers are required to ensure that the heat pump remains clean and free from debris.
- DO NOT USE FLAMMABLE CLEANING PRODUCTS.



Before cleaning



After cleaning

- DO NOT PIERCE OR BURN THE SYSTEM.
- Do not use means to accelerate the defrosting process or to clean, other than those recommended by the manufacturer.
- The appliance shall be stored in a room without continuously operating ignition sources (for example: open flames, an operating gas appliance, or an operating electric heater).
- Be aware that refrigerants might not contain an odor.
- Please check the machine regularly for any damage, if there is obvious damage, please contact our maintenance team. In some cold areas (below zero degrees Celsius), if the system stops working for a long time, all the water in the water tank should be released and re-installed in the water tank to prevent ice formation in the water cylinder.
- The water supply to rainwater storage tanks within urban agglomerations can be corrosive due to the dissolution of atmospheric pollutants.
- HOLIDAY MODE: This unit will automatically reduce power consumption when not in use, using only a small amount of power for self cleansing, do not turn the heat pump off.
- Service technicians MUST contact Ecogenica before attempting to re-charge this system, if repairs, or a leak is detected.



FLAMABLE GAS

This unit contains R290 Remove the R290 before disposal or hot gas service work. R290 is non Ozone depleting refrigerant grade propoane.

- LEAK DETECTION: Under no circumstances shall potential sources of ignition be used for the detection of leaks. If electronic leak detectors are to be used they must be calibrated and suitable for use with flammable natural gas or refrigerant grade propane (R290).
- If any hot work is to be conducted on the refrigeration system, an appropriate fire extinguisher shall be at hand containing dry powder or CO₂.
- NO SMOKING signs must be displayed if work on the refrigeration system is being conducted. No person carrying out work in relation to the refrigeration system, which involves exposing any pipe work, shall use any source of ignition in such a manner that it can lead to the risk of fire or explosion.
- Check to see that the condensation drain is not blocked. To ensure the faultless operation, the unit must be installed vertically with a tilt no more than 2°, preferably in the direction of the condensate drain in order to favour the condensates drainage.
- The anode is installed in your water heater to protect the cylinder, but it will slowly wear out over time. It is recommended that you replace the anode during a five-year service, or before if you have poor water quality in your area.

6. System Maintenance

REPAIR PROCEDURE

Ecogenica normally return heat pumps if repairs are to be conducted. If repairs are to be completed on site, approval from Ecogenica must be obtained in writing, and the following checklist must be conducted, to ensure fire risks are managed with best practices are implemented.

Repair Check List:

1. **Carry out repair work under controlled procedures** to ensure the lowest risk by flammable gases or vapors arising during the operation.
2. **All repair technicians and maintenance personnel in the work area shall be aware** of the nature of the job. Do not operate in the sealed space. Working area should be properly isolated to control combustible material to ensure a safe working condition.
3. **Refrigeration leak detection must be conducted** with equipment that is approved for R290 leak detection. Make sure that detector is suitable for flammable refrigerant leak: and does not spark. Before and during working process, refrigerant shall be detected with appropriate detector **around the Ecogenica Heat Pumps**. Ensure that technical staff are aware of combustible gas leak potential. The usage of refrigerant displayed on machine identification card inside.
4. **A fire extinguisher must be placed at the site** near where the heat pumps being worked on. When the refrigeration system, or related components, are under heat processing operations, it shall be noted that dry powder or carbon dioxide fire extinguisher shall be placed nearby.
5. **Before starting the work, make sure the surrounding environment has no flammable fire hazard sources**. A No -Smoking sign must be placed at the site. Take care to note that risks to fire, or explosion hazards, are not being used, including smoking.
6. **If flammable refrigerants are released into the surrounding environment, repair work MUST stop** and technicians, installers and people conducting repair works must stay away until all flammable gases have been dispersed. Flammable refrigerant pipe related work can only be conducted when R290 gases are removed from the site.
7. **Ventilation is essential**. Make sure the work area is adequately ventilated before opening the system or operating thermal processing. Make sure the site has enough ventilation to ensure the leaking refrigerant is release into the atmosphere safely and rapidly.
8. **During transport, installation or use, please be careful** not to damage any of the heat pumps refrigeration circuit. Sparks may result in explosion, fire or burning. This product uses natural hydrocarbon refrigerants (R290) as an environmentally friendly refrigerant, so even a small amount of leakage can also cause a fire.
9. **The electrical equipment should not be placed under the unit** or where refrigerant could gather **in** the event of a leak. Sparks may result **in** explosion, fire or burning. If leaks occur, eliminate open flames or potential sources of ignition with a fire extinguisher suitable for the R290 model). R290 ejected from damaged piping can cause burn or eye injury.
10. **All parts or heat pumps that are to be discarded must comply with product recycling laws** and regulations; customers are not allowed to discard appliances themselves. Disposal process shall comply with national environmental protection, labor safety and personnel health requirements.
11. If the tank is to removed ensure that hot water is drained safely into drains and away from building structure, people, walk ways and the Ecogenica Heat Pump.

7. Specifications & Drawings

Description	W Series 450/4.8kW	W Series 450/3.6kW	W Series 215/3.6kW
Model	EG-450FRECW-4.8HP-4.8E	EG-450FRECW-3.6HP-4.8E	EG-215FREC-W
Wi-Fi	Yes	Yes	Yes
Number of sensors	2	2	2
Tank Volume	450 L	450 L	215 L
Input Power	1023 W	735.6 W	630 W
Energy Savings	78%	79%	80.00%
Total thermal capacity (kW)	10.27	8.47	7.54
Recovery rate (Litres/Hour) HP/HP&Boost	103/206	77/181	55/117
Set hot water temperature °C	65	65	65
Heat Pump Heating Capacity	4,764W	3,553 W	3,150 W
COP	4.6 W/W	4.8 W/W	5.0 W/W
Booster Electric Element Heat Capacity	4,800 W	4,800 W	3,600 W
Fittings (inlet & outlet)	32mm / G1 ¼	32mm / G1 ¼"	20mm / G ¾
Return inlet	32mm / G1 ¼	32mm / G1 ¼"	N/A
Height	1835 mm	1835 mm	1800 mm
Width	700 mm	700mm	510mm
Heat Pump Size Height	610 mm	545mm	545mm
Width	840 mm	780mm	780mm
Depth	313mm	276mm	276mm
Circuit breaker Amps:	32	32	25
Power Supply	220-240V/50Hz	220-240V/50Hz	220-240V/50Hz
Operating Temperature Range	-7°C ~+43°C	-7°C ~+43°C	-7°C ~+43°C
Refrigerant Type	R290	R290	R290
Protection Ranking Class	IPX4	IPX4	IPX4
Connection	Split Quick	Split Quick	Split Quick

- All listed specification are measured at inlet water temperature +14°C; Dry Bulb Temperature +19°C, wet bulb temperature 15°C, and hot water set point 55°C .
- Recovery rates vary with environmental conditions.
- This water heater is with fully welded enamel tank meeting the design requirements: AS/NZS 2712 and AS/NZS 60335.2.40 This water heater complies with AS 3498 and AS/NZS 1677.2
- Maximum allowable pressure:4.4MPa.
- Maximum temperature setting is 65 °C.

7. Specifications & Drawings

EG-215FREC-W

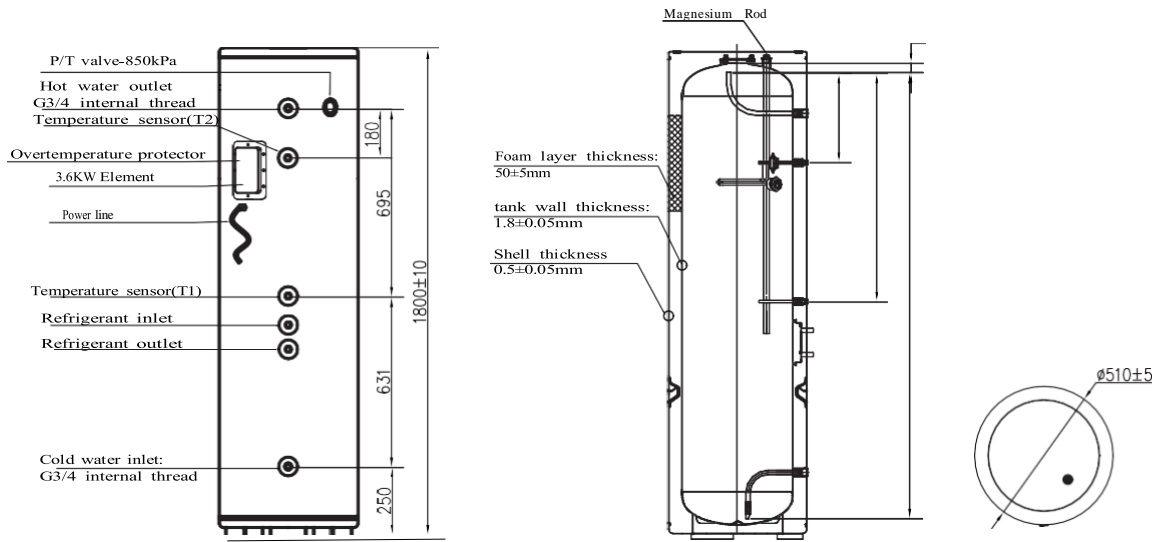

EG-450FRECW-3.6HP-4.8E

EG-450FRECW-4.8HP-4.8E

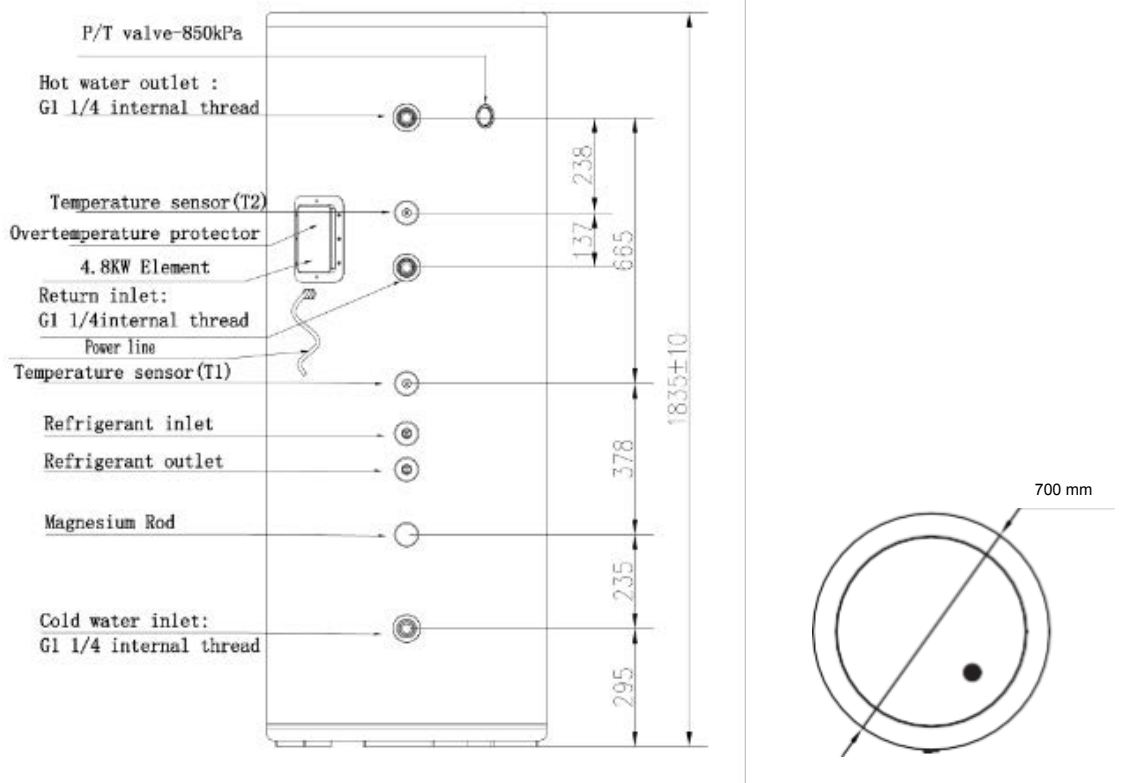

7. Specifications & Drawings

W-Series Split Exploded View

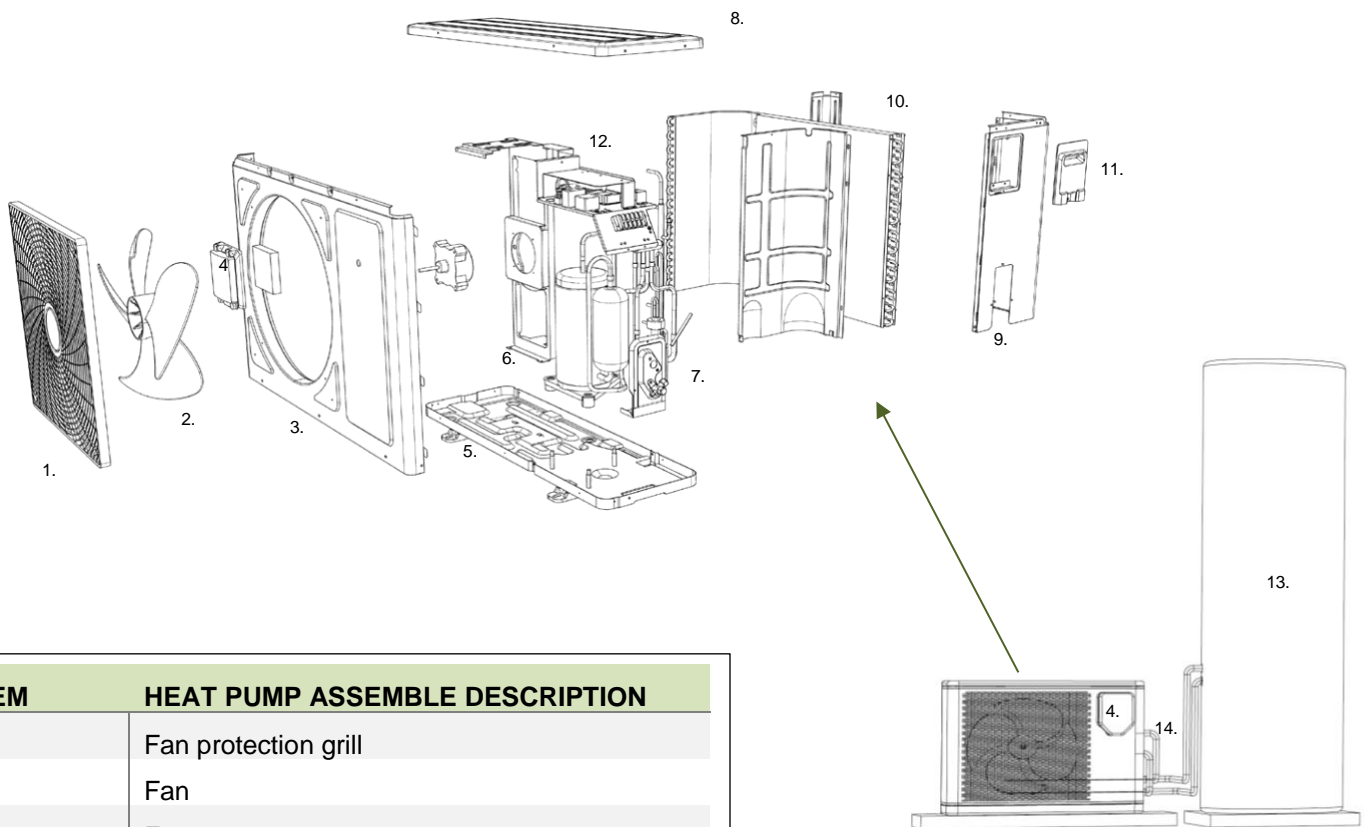

ITEM	HEAT PUMP ASSEMBLE DESCRIPTION
1	Fan protection grill
2	Fan
3	Front cover
4	Controller – Wi-Fi, temperature, timer.
5	Condensation drain
6	Compressor assemble
7	Schrader valve & Quick condenser connection
8	Top cover
9	Rear casing assemble
10	Evaporator
11	Power cable cover
12	Circuit board
13	Condenser tank
14	Condenser pipe (pair coil)



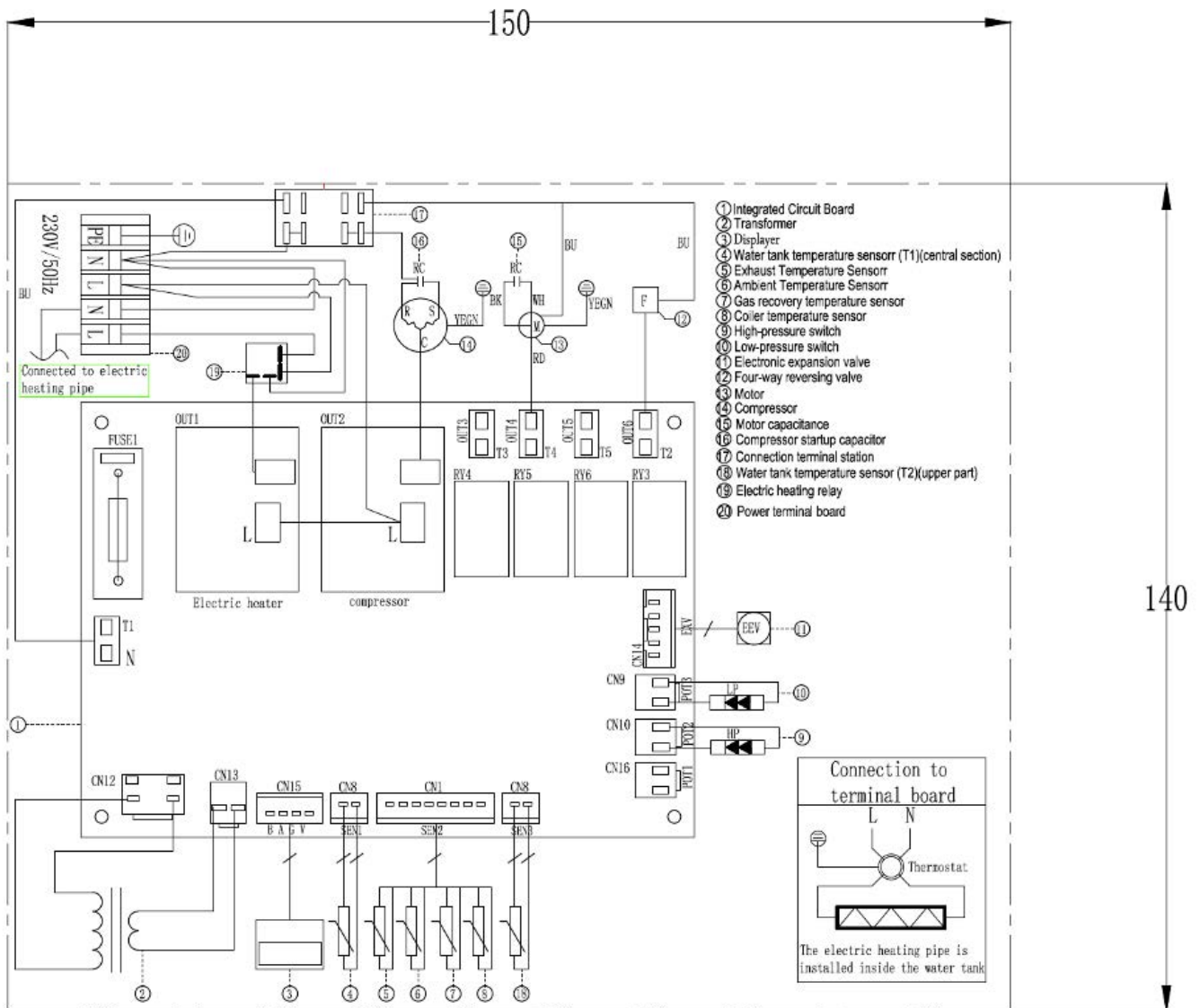





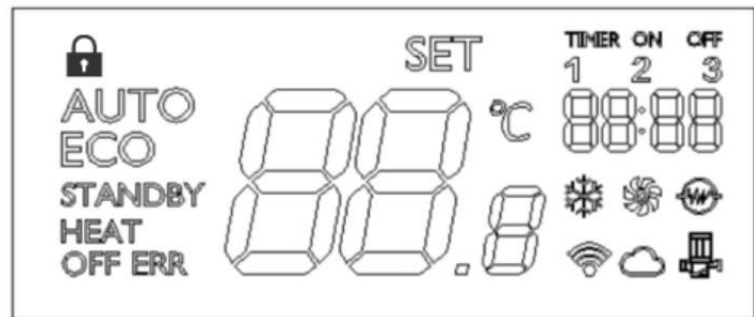



8. Electrical & Controls



- | | |
|--|---|
| 1 - Integrated Circuit Board | 13 - Motor |
| 2 - Transformer | 14 - Compressor |
| 3 - Display | 15 - Motor Capacitance |
| 4 - Water Tank Temperature Sensor T1 (central section) | 16 - Compressor Start-up Capacitor |
| 5 - Exhaust Temperature Sensor | 17 - Connection Terminal Station |
| 6 - Ambient Temperature Sensor | 18 - Water Tank Temperature Sensor (T2) (upper part) |
| 7 - Gas Recovery Temperature Sensor | 19 - Electric Heating Relay |
| 8 - Temperature Sensor | <ul style="list-style-type: none"> • 4.8 kW Element: EG-450FRECW-3.6HP-4.8E • 4.8 kW Element: EG-450FRECW-4.8HP-4.8E. |
| 9 - High Pressure Switch | |
| 10 - Low Pressure Switch | |
| 11 - Electronic Expansion Valve | |
| 12 - Four-way Reversing Valve | 20 - Power Terminal Board |













8. Electrical & Controls













1	AUTO Automatic Mode	All-day operation. Press  in “Automatic Mode” to switch to “Eco mode”
2	ECO Energy saving mode	Run in a fixed period. Press  in “Eco Mode” to switch to “Automatic Mode”
3	STANDBY	When the machine is in the standby state, the “STANDBY” icon is on
4	HEAT	When the machine is in the heat state, the “HEAT” icon is on
5	OFF	Long press the  for 3 seconds to power on (power off). When the machine is in the off state, the icon is on
6	ERR (Fault alarm)	When the machine fails, the icon is on. The fault type can be queried according to the fault alarm codes
7		Lock: (this function is blocked) Lock if no button is pressed in 60s, and press any button to unlock
8		The icon is on when the defrosting function is started
9		Fan on: when the fan is on, the  icon is on
10		Compressor on
11		Electrical heating on: when the electrical heating is on, the  icon is on
12		Wire controller WIFI: Long press  to enter the distribution network
13		Remote control: Connected to the cloud

8. Electrical & Controls



1		<p>On/Off:</p> <ul style="list-style-type: none"> • Long press  for 3 seconds to turn on (off)
2		<p>Set temperate:</p> <ul style="list-style-type: none"> • Press  or  to view the temperature set. After setting, press  to save settings and exit. (It is valid after the key is released).
3		<p>Set working mode:</p> <ul style="list-style-type: none"> • Press  to release and switch between “Automatic mode” and “Energy-saving mode”. Under the “Energy-saving mode”, run according to the working period set (It is valid after the key is released).
4		<p>Set time:</p> <ul style="list-style-type: none"> • Press  to enter the time setting. The time adjustment shall be as follows: Hour → Clock → Exit setting • Press  and  to adjust the corresponding time value • Exit automatically if no key is pressed within 30 seconds • Press  to exit during setting

8. Electrical & Controls

5		<p>Setting the Timer on Your Heat Pump - the controller is mounted in weather proof casing on the Heat Pump.</p> <ol style="list-style-type: none"> 1. Press and hold the clock icon for 5 seconds until "Timer 1" appears on the display. 2. Use the "+" and "-" buttons to set the desired "on" time for Timer 1, then press the clock icon again until "Timer 1 off" appears. Use the "+" and "-" buttons to set your desired "off" time. 3. If you wish to set additional timers, repeat this process for Timer 2 and Timer 3. 3. 4. If you only need one on/off cycle, make sure to zero out Timers 2 and 3 using the "+" and "-" buttons. 5. Once all timers are set, press the "M" icon to activate ECO mode. This will run the unit according to your selected timer settings.
6		<p>Factory parameter setting (RST):</p> <ul style="list-style-type: none"> • Press "Reset (RST)" for three times continuously to enter the factory parameter setting. The parameter adjustment mode is the same as that of "Advanced setting". The parameter adjustment mode will fix factory parameters.
7		<p>Parameters restore to factory default parameters (RST):</p> <ul style="list-style-type: none"> • Under the non-set state, long press "Reset (RST)" for more than 4 seconds to display "dEF", at this time, press  to restore the current parameters to factory parameters.
8		<p>Manual forced defrosting:</p> <ul style="list-style-type: none"> • Long press  for 10 seconds to start defrosting forcibly and exit when the maximum defrosting time is reached or the protection fails.
9		<p>View the current value:</p> <ul style="list-style-type: none"> • Press  and  simultaneously to view the current value. It will run normally after they are released.
10		<p>Remote control: Long press  to enter the distribution network</p>

8. Electrical & Controls

Startup:

Power On: Press “” for 3 seconds

Factory parameter setting:

- Compressor opens automatically at 2:00 P.M. daily if water temperature is less than 60 °C
- Constant temperature shutdown and standby status opened when:
 - ĩ Disinfect open once a daily 2:00 p.m.
 - ĩ The commercial model default is: 65 °C
 - ĩ The Maximum temperature setting is 65 °C
- Power Off: Press “” for 3 seconds
- Disinfection control is hard wired into the circuit board and cannot be altered by:
 - ĩ Changes to temperature set points.
 - ĩ Changes to dead band settings (on/off activations).
 - ĩ Timer activations.

	CONTENT	FAULT CODE	HEAT PUMP STATUS	NOTES
1	Freeze Protection	A11	If frosting detected, then - reverse cycle	Automatic recovery
2	Low voltage switch protection	A12	stop heating	power off then power on
3	High voltage switch protection	A13	stop heating	Automatic recovery
4	Water tank temperature sensor failure	A21	stop heating	Automatic recovery
5	Coil temperature sensor failure	A22	stop heating	Automatic recovery
6	Exhaust temperature sensor failure	A23	stop heating	Automatic recovery
7	Ambient temperature sensor failure	A25	stop heating	Automatic recovery
8	Intake air temperature sensor failure	A26	stop heating	Automatic recovery
9	Operator cable interruption protection	A51	stop heating	When the VCC and GND lines are opened, the operator does not light up; when the A and B lines are opened, the operator displays the A51 fault code
10	Exhaust temperature high temperature protection	A61	stop heating	3 times/hour the heat pump stops working

9. Warranty

Disclaimer: All our Hat Pump's systems must be installed by a licensed and certified installer ensuring all local, state and national regulations are met. Failure to do so will void this warranty.

NOTICE TO CUSTOMER

Our goods come with guarantees that cannot be excluded under the Australian Consumer Law. You are entitled to a replacement or refund for a major failure and compensation for any other reasonably foreseeable loss or damage. You are also entitled to have the goods repaired or replaced if the goods fail to be of acceptable quality and the failure does not amount to a major failure.

Note: We recommend all consumers safely store receipts, invoices, warranties, and any installation records to allow for faster processing of warranty claims.

11 TERMS OF WARRANTY

1. The warranty terms in this Ecogenica Customer Product Manual relates to the Ecogenica FREC-W & /FREC W Range of Heat Pump Water Heater System, namely: Ecogenica® EG-215FREC-W; EG-450FRECW-3.6HP-4.8E & EG-450FRECW-4.8HP-4.8E models.

The warranty period are as follows from the date of installation:

- 7 Year warranty for the Tank
5 Year warranty for the Compressor
2 Year warranty for Servicing,
- 2 years for Parts only and all Labor costs associated with diagnosis, removal of the faulty part and installation of replacement parts will solely be the owner's responsibility and solely at the owner's cost.

The benefits conferred by this Warranty are in addition to all other rights and remedies in respect of the Heat Pump Water Heater System, which the purchaser has under the law including the Competition and Consumer Act 2010 and consumer protection legislation of the States and Territories. Nothing in this Warranty has the effect of excluding, restricting or modifying those rights.

2. Ecogenica will repair or provide parts for repair or replacement, where defects arise from faulty materials.
3. Ecogenica is responsible for reasonable costs associated with legitimate warranty claims, as determined by Ecogenica. To determine whether a warranty claim is legitimate, Ecogenica may send an Ecogenica accredited service agent to inspect the product. Ecogenica is not responsible for:
 - (a) any costs that are not pre-approved in writing by Ecogenica; and
 - (b) any costs associated with a product which is determined upon inspection not to be covered by this warranty.

Any reasonable costs incurred by the consumer that is associated with making a legitimate warranty claim will be reimbursed by Ecogenica.

Inquiries relating to warranty coverage and claims for Ecogenica products or services must be made by contacting Ecogenica.

An Ecogenica accredited service agent or the Ecogenica service department can repair or replace product components, subject to Ecogenica terms and conditions of warranty. Ecogenica can, in addition, provide information on operation and maintenance of Ecogenica products. Ecogenica contact details are on the back of this document.

12 WARRANTY CONDITIONS

1. The person making the claim must be the owner of the Product or have written authorisation to act on behalf of the owner which must be provided to Ecogenica.
2. The person making the claim must notify Ecogenica as soon as they notice any defects without delay, and the product must be within its warranty period as set out in the terms of warranty.
3. The warranty applies to products manufactured on or after the date of publication of this warranty.
4. The terms of warranty take effect from the date of completion of installation of the Product and full payment of the Product. Ecogenica reserves the right to request proof of purchase or a copy of the certificate of compliance (this is required by law to be issued by the installer) to verify the date of completion of installation prior to commencing any warranty work. Where the date of completion of installation is not known, then this warranty will commence 2 months after the date of manufacture. The date of manufacture is stated on the data plate of the appliance.
5. Prior to any inspection, service, repair or replacement undertaken pursuant to the warranty on a Heat Pump Water Heater System, the following must occur:
 - a. The warranty works must be authorised by Ecogenica; and
 - b. Proof of purchase and the certificate of compliance must be submitted to Ecogenica.
6. The Heat Pump Water Heater System must be installed, commissioned, serviced, repaired and removed in accordance with the installation instructions supplied by Ecogenica for the Heat Pump Water Heater System, and in accordance with all relevant statutory and local requirements of the state/province/municipality in which the Heat Pump Water Heater System is installed.
7. All Heat Pump Water Heater Systems must be operated and maintained in accordance with the Ecogenica operating instructions.
8. The warranty only applies to the Heat Pump Water Heater System and original or genuine (company) component replacement parts provided by Ecogenica. The warranty does not cover any plumbing or electrical parts supplied by the installer and that is not an integral part of the Heat Pump Water Heater System. Such parts would include, but is not limited to, pressure regulating valve, limiting valves, check valves, tempering valves, electrical switches or fuses.

9. To the extent permitted by law, Ecogenica shall not be liable under this Warranty for any consequential loss or damage or any incidental expenses resulting from any breach of this warranty, including but not limited to, claims for damage to buildings, roofs, ceilings, walls, foundations, gardens, personal belonging or household effects, fixtures and fittings, or any other consequential loss, damage or inconvenience, either directly or indirectly due to the Heat Pump Water Heater System or component(s) related to the system or its operation including but not limited to leakage.
 10. Where a failed component or Heat Pump Water Heater System is replaced under warranty, the balance of the original warranty period will remain effective. The replaced part or Heat Pump Water Heater System does not carry a new warranty.
 11. Ecogenica reserve the right to have the installed product returned to the factory for inspection.
 12. Products eligible for repair may be replaced by refurbished goods of same type rather than being repaired. Refurbished parts may be used to repair/replace the Products.
 13. Where the Heat Pump Water Heater System is not installed in accordance with the installation instructions or installed in a position that does not allow safe, ready access as determined by the attending service person, the service may be refused at their discretion. Any cost to access the site safely, including the cost of additional materials, handling and/or safety equipment, will be charged to the consumer and will be the consumer's responsibility.
 14. The Heat Pump Water Heater System must be sized to supply the hot water demand in accordance with the guidelines in the Heat Pump Water Heater System Literature.
- 13 WARRANTY EXCLUSIONS**
Products supplied by Ecogenica are subject to warranties that cannot be excluded by law. Any breach of condition or warranty is limited to the repair or replacement of the Product, the supply of an equivalent Product, the payment of the cost of repairing or replacing the Product or acquiring an equivalent as determined by Ecogenica.
- Repair and replacement work will be carried out as set out in the Heat Pump Water Heater System terms of warranty. However, the following exclusions may void the warranty and may incur additional service charges and/or cost of parts:
15. Damage to the Heat Pump Water Heater System or any component, including accidental damage, natural disasters, acts of God, storm damage, vandalism.
 16. Failure due to abuse, misuse or neglect, improper maintenance, or failure to maintain and incorrect or unauthorised installations.
 17. Failure or damage caused by alterations, service or repair work carried out by persons other than Ecogenica accredited service agents or the Ecogenica service department.
 18. Where no fault is found with the Heat Pump Water Heater System or its components and the issue is related to the plumbing installation or is due to a direct or indirect failure of water, electric or gas supplies, corrosive atmosphere or other issues not caused by a fault of the Product including but not limited to:
 - (a) excessive discharge from the temperature and/or the pressure relief valve due to high water pressure.
 - (b) excessive water pressure.
 - (c) no flow of hot water.
 - (d) water leakage.
 - (e) where the supply of electricity or water does not comply with relevant codes or acts, or the power supply is cut;
 - (f) the overflow vent drain has not been installed or it is blocked or corroded.
 - (g) rust due to a corrosive atmosphere.
 19. Where the unit fails to operate or fails because of excessive cold or ice formation in the piping to or from the Heat Pump Water Heater System.
 20. Where any faults arise from connecting to a water source that is unfiltered such as dams, bores, rivers etc.
 21. The Heat Pump Water Heater System being relocated from its original point of installation.
 22. Operating the water heater and components when not filled with water.
 23. This warranty applies to Heat Pump Water Heater Systems connected to the energy source listed on the data label of the Product.
 24. This warranty does not apply to damage caused by sludge and/or sediment in the water supply.
 25. Repair and/or replacement of the Heat Pump Water Heater System due to scale formation above 200ppm. (water hardness) in the waterways or the effects of either corrosive water or water with a high chloride or low PH level when the water heater.
 26. Where the Ecogenica Heat Pump Water Heater System is in a position that does not comply with the Heat Pump Water Heater System installation instructions or relevant statutory requirements, causing the need to dismantle or remove cupboards, doors, or walls, or require the use of special equipment to bring the Heat Pump Water Heater System to floor or ground level or to a serviceable position.
 27. Labour costs incurred due to an Ecogenica accredited service agent performing checks which should have been carried out by the consumer in accordance with the operating instructions and where no defect is found.

“Water heating is the second largest source of greenhouse emissions accounting for almost a quarter of household energy use.”



ECOGENICA

Your new ECOGENICA® W-Series series heat pump uses a small amount of energy to move heat from one location to another. Heat is absorbed by ozone-friendly R290, a natural refrigerant which does not contribute to global warming.

We support the Australian government in its commitment to transforming our energy supply system into one that is cheap, clean and reliable.

This lays the foundation for future generations to enjoy more secure, reliable and affordable energy.

You can choose an ECOGENICA® product safe in the knowledge that our innovative technology is focused on energy and environment savings. Our hot water pumps are CFC free and utilise renewable energy, extracted from the air.

CONTACT US:

CALL: 1300 341 010

VISIT: ecogenica.com.au

6 Braeside Drive, Braeside, Vic, 3195 Australia

ECOGENICA® –A smart choice for the environment a smart choice for you